

TABLE OF CONTENTS

<u>Redweld® Expanding File Pockets</u>	<u>2</u>
<u>Redweld® Shelf Pockets</u>	<u>4</u>
<u>Redweld® Expanding Envelopes</u>	<u>5</u>
<u>Econoline Expanding File Pockets</u>	<u>6</u>
<u>CarryPac®, Presentation Folders, Tax and Audit Report Covers</u>	<u>7</u>
<u>Intellectual Property Folders</u>	<u>8</u>
<u>Redweld® File Jackets</u>	<u>10</u>
<u>Redweld® End Tab Folders</u>	<u>11</u>
<u>Pressboard & Classification Folders</u>	<u>13</u>
<u>Exhibit Dividers</u>	<u>15</u>
<u>Mailing Envelopes</u>	<u>18</u>
<u>Redweld® Retention Pockets</u>	<u>19</u>
<u>Filing Accessories—Labels</u>	<u>20</u>
<u>Filing Accessories—Outguides</u>	<u>21</u>
<u>Made-to-Order</u>	<u>22</u>



REDWELD® EXPANDING FILE POCKETS

Reliability, consistency, quality. That's what customers demand in expandable file pockets and that's what Redweld® delivers.

Redweld® Expanding File Pockets are durable, adding strength to individual filing applications and lasting beyond the retention schedule.

Letter Size

Stock #	Size	Exp.	Gusset	Gusset Ht.	Qty/Ctn
1524 E	9½" x 11¼"	3½"	Paper	6½"	50
1534 G	9½" x 11¼"	5"	Paper	6½"	50

Legal Size

Stock #	Size	Exp.	Gusset	Gusset Ht.	Qty/Ctn
1526 EN	9½" x 14¾"	3½"	Paper	6½"	50
1536 GN	9½" x 14¾"	5"	Paper	6½"	50
1526 ET	10" x 15"	3½"	Paper	6½"	50
1536 GT	10" x 15"	5"	Paper	6½"	50

Legal Size—Full Height Gusset

Stock #	Size	Exp.	Gusset	Gusset Ht.	Qty/Ctn
155 SP	9½" x 14¾"	3½"	Paper	9½"	50
156 SP	10" x 15"	3½"	Paper	10"	50
156 SP Jute	10" x 15"	3½"	Paper	10"	50
176 SP	10" x 15"	5"	Paper	10"	50

Legal Size—Top Side Tab

Stock #	Size	Exp.	Gusset	Gusset Ht.	Qty/Ctn
1526 TST	10" x 15½"	3½"	Paper	6½"	50

Legal Size—Metal Tab

Stock #	Size	Exp.	Gusset	Gusset Ht.	Qty/Ctn
1526 MT*	9½" x 15"	3½"	Paper	6½"	50

*Metal Tabs are in assorted positions

Legal Size—Metal Tab—Full Height Gusset

Stock #	Size	Exp.	Gusset	Gusset Ht.	Qty/Ctn
156 MT*	10" x 15"	3½"	Paper	10"	50

*Metal Tab on right front position



REDWELD® EXPANDING FILE POCKETS

Redweld® Expanding File Pockets feature the unmatched strength of Tyvek®. Virtually impossible to tear, our Tyvek® gusset is highly pliable, easily expandable while retaining its shape and strength.

Constructed of acid-free materials, Redweld® Expanding File Pockets will protect and preserve documents, photographs, and other valuable contents.

Tyvek® is a registered trademark of Dupont for its brand of protective material.

Letter Size—File Pocket

Stock #	Size	Exp.	Gusset	Gusset Ht.	Qty/Ctn
1534 KG	9½" x 11¾"	5¼"	Tyvek®	6½"	50

Legal Size—File Pocket

Stock #	Size	Exp.	Gusset	Gusset Ht.	Qty/Ctn
1526 KGN	9½" x 14¾"	3½"	Tyvek®	6½"	50
1536 KGN	9½" x 14¾"	5¼"	Tyvek®	6½"	50
1526 KGT	10" x 15"	3½"	Tyvek®	6½"	50
1536 KGT	10" x 15"	5¼"	Tyvek®	6½"	50

Legal Size—Full Height Gussets

Stock #	Size	Exp.	Gusset	Gusset Ht.	Qty/Ctn
155 KG	10" x 15"	3½"	Tyvek®	10"	50
176 KG	10" x 15"	5¼"	Tyvek®	10"	50

Legal Size—Tyvek® Colored Gussets*

Stock #	Size	Exp.	Gusset*	Gusset Ht.	Qty/Ctn
1526 KGN-C	9½" x 14¾"	3½"	Tyvek®	6½"	50
1536 KGN-C	9½" x 14¾"	5¼"	Tyvek®	6½"	50
1526 KGT-C	10" x 15"	3½"	Tyvek®	6½"	50
1536 KGT-C	10" x 15"	5¼"	Tyvek®	6½"	50

*Please specify gusset color when ordering

Stock Tyvek® Gusset Colors:

105 Frosty White	130 Scarlet Red	119 Lemon Yellow	124 Lime	143 Cerulean Blue
106 New Brown				

Custom Tyvek® Gusset Colors:

100 Black	132 Dusty Rose	114 Russet	133 Orange	131 Blue/Violet
117 Taupe	152 Pearl Green	194 Manila	123 Avocado	115 Desert Sand
192 Goldenrod	126 Moss Green	142 Pale Blue	157 Dove Gray	150 Banker's Gray
134 Magenta	120 Spring Green	111 Chocolate Brown	145 Dark Blue	135 Maroon



REDWELD® SHELF POCKETS

Redweld® Shelf Pockets feature the durable 5-piece construction and include a side tab for shelf filing. The self tab, available as a manila or metal tab, is located on the right side of the pocket.

Flexible Tab

Premium 5-piece construction with a full flexible end tab, allows the file to move from active status to inactive or offsite storage and return to active status with a flip of the flexible tab.

Letter Size—Full Right Side Tab—Notch

Stock #	Size	Exp.	Gusset	Gusset Ht.	Qty/Ctn
1534 KGNFST	9½" x 12½"	5¼"	Tyvek®	6½"	50

Legal Size—Full Right Side Tab—Notch

Stock #	Size	Exp.	Gusset	Gusset Ht.	Qty/Ctn
1526 NFST	9½" x 15½"	3½"	Paper	6½"	50
1526 KGNFST	9½" x 15½"	3½"	Tyvek®	6½"	50
1536 NFST	9½" x 15½"	5¼"	Paper	6½"	50
1536 KGNFST	9½" x 15½"	5¼"	Tyvek®	6½"	50

Legal Size—Full Flexible Side Tab—No Notch

Stock #	Size	Exp.	Gusset	Gusset Ht.	Qty/Ctn
1526 KGFST	10" x 15¼"	3½"	Tyvek®	6½"	50
1536 KGFST	10" x 15¼"	5¼"	Tyvek®	6½"	50

Legal Size—Side Shelf Tab—4" Long Right Side

Stock #	Size	Exp.	Gusset	Gusset Ht.	Qty/Ctn
1526 KGSFM	9½" x 15¼"	3½"	Tyvek®	5½"	50
1536 KGSFM	9½" x 15¼"	5¼"	Tyvek®	5½"	50

Legal Size—Side Shelf Tab—3½" Long Right Side

Stock #	Size	Exp.	Gusset	Gusset Ht.	Qty/Ctn
1526 SF	9½" x 15¼"	3½"	Paper	6"	50

Legal Size—Full Right Side—Flexible Tab

Stock #	Size	Exp.	Gusset	Gusset Ht.	Qty/Ctn
1526 NFST	9½" x 15½"	3½"	Paper	6½"	50
1536 NFST	9½" x 15½"	5¼"	Paper	6½"	50

Legal Size—Metal Tab, Installed on Pressboard Liner

Stock #	Size	Exp.	Gusset	Gusset Ht.	Qty/Ctn
1526 KGS	9½" x 15"	3½"	Tyvek®	5½"	50
1536 KGS	9½" x 15"	5¼"	Tyvek®	5½"	50



REDWELD® EXPANDING ENVELOPES

Redweld® premium 5-piece constructed Expanding Envelopes are available with a variety of closures; including original cloth tie, 1B elastic and the exclusive fast elastic (FE).

Legal Size—Cloth Tie Closure

Stock #	Size	Exp.	Gusset	Qty/Ctn
1055 E	9½" x 14¾"	3½"	Paper	50
1075 KG	9½" x 14¾"	5¼"	Tyvek®	50
1056 E	10" x 15"	3½"	Paper	50
1056 KG	10" x 15"	3½"	Tyvek®	50
1076 G	10" x 15"	5¼"	Paper	50
1076 KG	10" x 15"	5¼"	Tyvek®	50

Legal Size—1B Elastic Closure— Tyvek® Reinforced Flap with Rivets

Stock #	Size	Exp.	Gusset	Qty/Ctn
1056 KG 1BR	10" x 15"	3½"	Tyvek®	50
1076 KG 1BR	10" x 15"	5¼"	Tyvek®	50

Legal Size—FE Elastic Closure

Stock #	Size	Exp.	Gusset	Qty/Ctn
FE1075 KG	9½" x 14¾"	5¼"	Tyvek®	50
FE1056 KG	10" x 15"	3½"	Tyvek®	50
FE1056 E	10" x 15"	3½"	Paper	50
FE1076 KG	10" x 15"	5¼"	Tyvek®	50
FE1076 G	10" x 15"	5¼"	Paper	50

Pocket with Extended Flap—Cloth Tie Closure

Stock #	Size	Exp.	Gusset	Gusset Ht.	Qty/Ctn
1576 KG	10" x 15"	5¼"	Tyvek®	6½"	50

CUSTOM-TAILORED
**EXPANDING
ENVELOPES**
see pgs 22-24



ECONOLINE EXPANDING FILE POCKETS

Redweld® Econoline Expanding File Pockets provide reliable performance at economical pricing and are perfect for general use filing. The red fiber paper gussets are reinforced at the top with Tyvek® overlap. Five piece construction allows for added strength. The Tyvek® gussets are reinforced with Mylar which strengthens the inside gusset edge to resist tearing. Whether paper or Tyvek® gussets, Econoline Pockets provide strength and durability when compared to similar office supply brand pockets.

Letter Size—File Pockets

Stock #	Size	Exp.	Gusset	Gusset Ht.	Qty/Ctn
EC1524	9½" x 11¾"	3½"	Paper	6½"	50
EC1524KG	9½" x 11¾"	3½"	Tyvek®	6½"	50
EC1534	9½" x 11¾"	5¼"	Paper	6½"	50
EC1534KG	9½" x 11¾"	5¼"	Tyvek®	6½"	50

Legal Size—File Pockets

Stock #	Size	Exp.	Gusset	Gusset Ht.	Qty/Ctn
EC1526	9½" x 14¾"	3½"	Paper	6½"	50
EC1526KG	9½" x 14¾"	3½"	Tyvek®	6½"	50
EC1536	9½" x 14¾"	5¼"	Paper	6½"	50
EC1536KG	9½" x 14¾"	5¼"	Tyvek®	6½"	50

CUSTOM-TAILORED
**EXPANDING
 FILE POCKETS**

see pgs 22-24



CARRYPAC® • PRESENTATION FOLDERS • REPORT COVERS

Complete the package with premium Redweld® custom 5-piece expansion portfolios. Custom expanding portfolios offer an innovative, versatile and unique way to present all information. Redweld® Presentation Products are the perfect solution for client presentations, recruitment, benefits/new employee kits and summer associate programs.

CarryPac®

Versatile CarryPac® portfolios offer an outstanding application for a wide range of firm and corporate uses. Use CarryPac® as an attractive, durable portfolio anywhere dependable, portable filing is needed. CarryPac® can be printed to promote identity and reinforce brands.

Presentation Folders

Present documents in a professional and impressive format with a Redweld® Presentation Folder. Folders can be personalized with custom printing with the firm logo and name. To personalize, choose from a variety of stock colors and formats.

Tax Return and Audit Report Covers

Tax Return and Audit Report Covers offer a professional appearance. Redweld® covers are made of 65 lb. linen stock, available in four stock colors and a variety of styles. Utilize one of our standard forms or customize the cover. To complete, send the client's report in a Redweld® Professional Mailer, see page 18.

Tax Return Covers

Stock #	Size	Color	Qty/Ctn
09061	8¾" x 11¼"	Blue Linen	300
09261	8¾" x 11¼"	White Linen	300
09361	8¾" x 11¼"	Light Grey Linen	300
09461	8¾" x 11¼"	Dark Grey Linen	300

Audit Report Covers

Stock #	Size	Style	Qty/Ctn
09010*	8¾" x 11¼"	Two Piece	300
09020*	8¾" x 11¼"	Single Fold	300
09030*	8¾" x 11¼"	W-Fold	300
09040*	8¾" x 11¼"	Multiple Fold	300
09700	8¾" x 11¼"	Back Only	300
09701	8¾" x 11¼"	Printed Front Only	300

*Report covers are plain but can be customized.



INTELLECTUAL PROPERTY

Intellectual Property

Intellectual Property Folders allow customers to file and organize patent and trademark applications. Interior leafs are punched to accommodate a fastener to hold documents received from the Patent and Trademark Office or from clients. Ideal for maintaining and organizing correspondence and drawings.

Patent Application Folder

Stock #	Size	Description	Qty/Ctn
8029-200	9½" x 14¼"	200# Jute Patent Application	100

U.S. Trademark Folder

Stock #	Size	Description	Qty/Ctn
7039-2LB	9½" x 14¼"	Blue Trademark—2 leaf	100
7039-2LS	9½" x 14¼"	Salmon Trademark—2 leaf	100
7039-3LB	9½" x 14¼"	Blue Trademark—3 leaf	100
7039-3LS	9½" x 14¼"	Salmon Trademark—3 leaf	100

Foreign Patent Folder

Stock #	Size	Description	Qty/Ctn
9019-2LB	9½" x 14¼"	Blue Foreign—2 leaf	100
9019-2LS	9½" x 14¼"	Salmon Foreign—2 leaf	100
9019-3LB	9½" x 14¼"	Blue Foreign—3 leaf	100
9019-3LS	9½" x 14¼"	Salmon Foreign—3 leaf	100

CUSTOM-TAILORED PATENT AND TRADEMARK FOLDERS

Design a folder with tabs, color-coded reinforcement, expansion capacity or custom imprint the company's form.

Designing custom-tailored Patent or Trademark Folders.

In designing a filing system, consider color-coding as another way to enhance performance in the filing area. Select from our 12 durable bristol stocks. 26 Tyvek® gusset colors are used to create an expandable folder and establish a personal filing system.

Custom printing the company's logo, handling instructions and special forms allows for the ability to track important information, or simply utilize one of the standard forms.

Pockets and fasteners provide another option for keeping content organized.

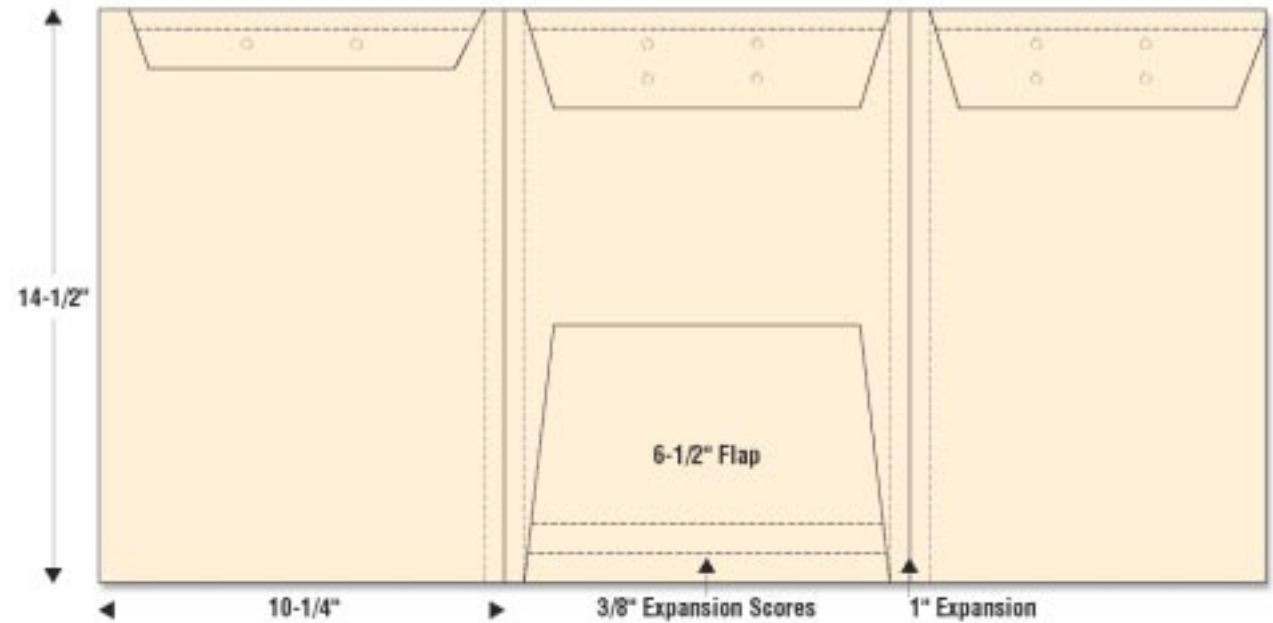

A form with a grid structure, likely for tracking patent applications, with various fields for data entry.

Patent Application Form

A form with multiple sections and fields, likely for tracking U.S. trademark applications.

U.S. Trademark Application Form

A form with multiple sections and fields, likely for tracking foreign trademark applications.

Foreign Trademark Application Form



REDWELD® FILE JACKETS

Durable, 1-piece File Jackets secure documents that cannot be hole-punched and vary in size. Accessing items requires minimal filing and retrieval effort because the documents are not attached to a folder. Three closed sides are available for additional security. Two closed sides and angle-cut fronts provide the easiest access to, and fastest retrieval of jacket contents.

Flat Jackets-Single Tab

Letter Size- Overall: 9½" x 11¼" Body: 8¾" x 11¼"

Stock #	Sub Wt.	Color	Qty/Bx	Qty/Ctn
F70006	6 pt.	Manila Kraft	250	1000
F70906	6 pt.	Golden Kraft	250	1000
F70916	6 pt.	White Kraft	250	1000
F70100	11 pt.	Manila (8¾"H)	100	500

Flat-Single Top Edge

Straight cut. 8 embossed score marks. Open top. Thumb cut.

Letter Size- Overall: 9½" x 12¼" (9" H drop front)

Stock #	Sub Wt.	Color	Qty/Bx	Qty/Ctn
F74200	11 pt.	Manila	100	500

Legal Size- Overall: 9½" x 15¼" (9" H drop front)

F75200	11 pt.	Manila	100	500
--------	--------	--------	-----	-----

Flat-Reinforced Top Edge

Straight cut. 8 embossed score marks. Open top. Thumb cut.

Letter Size- Overall: 9½" x 11¼" (8⅞" H drop front)

Stock #	Sub Wt.	Color	Qty/Bx	Qty/Ctn
F74100	11 pt.	Manila	100	500

Flat-Reinforced Tab

Full cut end tab. 8 embossed score marks. Open top and end. Diagonal cut front.

Letter Size- Overall: 9½" x 12¼" Body: 9½" x 11¼"

Stock #	Sub Wt.	Color	Qty/Bx	Qty/Ctn
F70110	11 pt.	Manila	100	500

Expanding File Jackets

1" reinforced tab. Thumb-cut front for easy content removal. Full gusset. Closed corners. Closed on three sides to prevent contents from sliding out.

Stock #	Size	Sub Wt.	Stock	Qty/Ctn
E9214	9½" x 11¼" x 1"	11 pt.	Manila	100
E9216	9½" x 11¼" x 1½"	11 pt.	Manila	100
E9220	9½" x 11¼" x 2"	11 pt.	Manila	100
E9232	9½" x 14¾" x 1"	11 pt.	Manila	100
E9235	9½" x 14¾" x 1½"	11 pt.	Manila	100
E9240	9½" x 14¾" x 2"	11 pt.	Manila	100

CUSTOM-TAILORED
FILE JACKETS

see pgs 22-24

Redweld® End Tab Folders

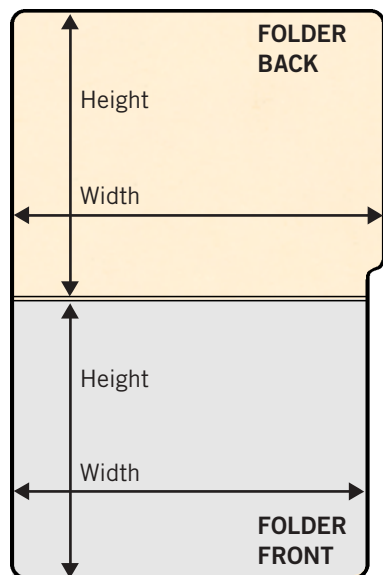

OVERALL SIZE

Body size plus the end tab

BODY SIZE

(Shaded area) Overall size minus the end tab

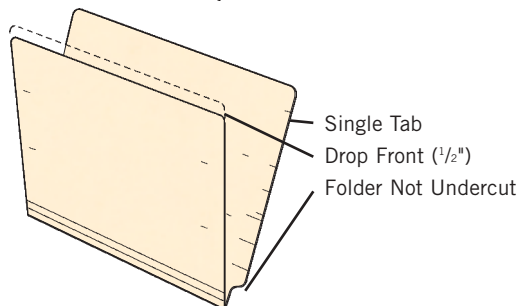
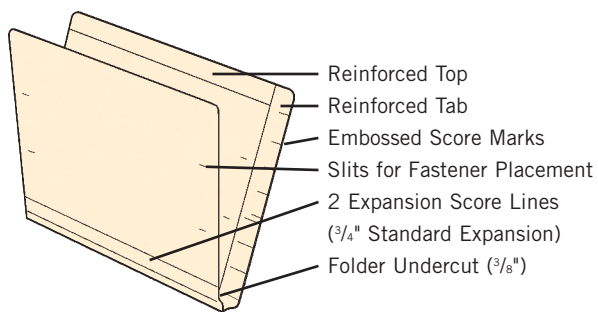

REDWELD® END TAB FOLDERS

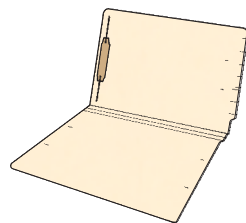

Letter—Single Tab with Fasteners

Full cut end tab. 8 embossed score marks. 2" capacity bonded fasteners. Folder front undercut.

Letter Size- Overall: 9½" x 12¼" Body: 9½" x 11¼"					
Stock #	Sub Wt.	Color	Position	Qty/Bx	Qty/Ctn
F16402	14 pt.	Manila	1	50	250
F16401	14 pt.	Manila	1 & 3	50	250

NOTE: See page 19 for fastener position chart.

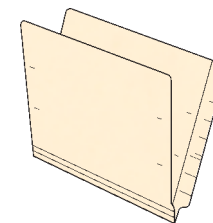

Letter—Reinforced Tab

Full cut end tab. 8 embossed score marks. 4 sets of slits. Folder front undercut.

Letter Size- Overall: 9½" x 12¼" Body: 9½" x 11¼" *DF=9"H drop front					
Stock #	Sub Wt.	Color	Qty/Bx	Qty/Ctn	
F20100	11 pt.	Manila	100	500	
F20100 DF*	11 pt.	Manila	100	500	
F20000	14 pt.	Manila	50	250	
F20000 DF*	14 pt.	Manila	50	250	
F22000	11 pt.	Blue	100	500	
F22100	11 pt.	Goldenrod	100	500	
F22200	11 pt.	Gray	100	500	

Letter—Reinforced Tab-Full Cut *continued*

8 embossed score marks. 4 sets of slits. Folder front undercut.

Letter Size- Overall Size: 9½" x 12¼" Body: 9½" x 11¼" *DF=9"H drop front

Stock #	Sub Wt.	Color	Qty/Bx	Qty/Ctn
F22300	11 pt.	Green	100	500
F22400	11 pt.	Lavender	100	500
F22500	11 pt.	Orange	100	500
F22600	11 pt.	Pink	100	500
F22700	11 pt.	Red	100	500
F22800	11 pt.	White	100	500
F22900	11 pt.	Yellow	100	500
F20040	15 pt.	Blue	50	250
F20041	15 pt.	Goldenrod	50	250
F20042	15 pt.	Gray	50	250
F20043	15 pt.	Green	50	250
F20044	15 pt.	Lavender	50	250
F20045	15 pt.	Orange	50	250
F20046	15 pt.	Pink	50	250
F20047	15 pt.	Red	50	250
F20048	15 pt.	White	50	250
F20049	15 pt.	Yellow	50	250

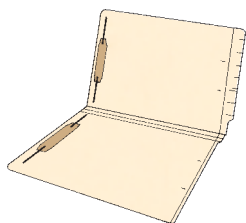

Letter—Reinforced Tab with Fasteners

Full cut end tab. 8 embossed score marks. 2" capacity bonded fasteners installed. Folder front undercut.

Letter Size- Overall: 9½" x 12¼" Body: 9½" x 11¼"

Stock #	Sub Wt.	Color	Position	Qty/Bx	Qty/Ctn
F20102	11 pt.	Manila	1	50	250
F19997	11 pt.	Manila	3 & 5	50	250
F20101	11 pt.	Manila	1 & 3	50	250
F20002	14 pt.	Manila	1	50	250
F19998	14 pt.	Manila	3 & 5	50	250
F20001	14 pt.	Manila	1 & 3	50	250
F20136	11 pt.	Blue	1 & 3	50	250
F20137	11 pt.	Green	1 & 3	50	250
F20139	11 pt.	Red	1 & 3	50	250
F20138	11 pt.	Yellow	1 & 3	50	250

NOTE: See page 19 for fastener position chart.

Legal—Reinforced Tab-Full Cut

8 embossed score marks. 4 sets of slits. Folder front undercut.

Legal Size- Overall Size: 9½" x 15¼" Body: 9½" x 14¼" *DF=9"H drop front

Stock #	Sub Wt.	Color	Qty/Bx	Qty/Ctn
F21100	11 pt.	Manila	100	500
F21100 DF	11 pt.	Manila	100	500
F23000	11 pt.	Blue	100	500
F23100	11 pt.	Goldenrod	100	500
F23200	11 pt.	Gray	100	500
F23300	11 pt.	Green	100	500
F23400	11 pt.	Lavender	100	500
F23500	11 pt.	Orange	100	500
F23600	11 pt.	Pink	100	500
F23700	11 pt.	Red	100	500
F23800	11 pt.	White	100	500
F23900	11 pt.	Yellow	100	500
F21000	14 pt.	Manila	50	250

Legal

Legal Size- Overall Size: 9½" x 15¼" Body: 9½" x 14¼" *DF=9"H drop front

Stock #	Sub Wt.	Color	Qty/Bx	Qty/Ctn
05802	11 pt.	Blue	100	300
05803	11 pt.	Red	100	300
05804	11 pt.	Manila	100	300
05805	11 pt.	Salmon	—	225
05806	11 pt.	Green	100	300
05807	11 pt.	Gray	100	300
05808	11 pt.	Yellow	100	300

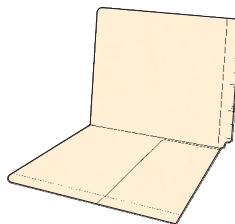

Letter—Drop Front Folders with Pocket

Full cut reinforced end tab. 5 embossed score marks. One piece construction. 5¾" x 9" pocket in position 4. 2 sets of slits. Folder front NOT undercut.

Letter Size- Overall: 9½" x 12¼" Body: (9"H drop front) x 11¼"

Stock #	Sub Wt.	Color	Qty/Bx	Qty/Ctn
F84000	11 pt.	Manila	50	250
F84100	14 pt.	Manila	50	250

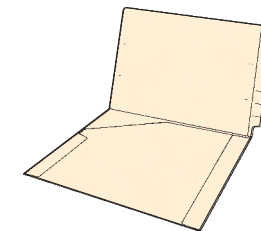

Letter—Manila Folders with Pocket

Full cut reinforced end tab. 8 embossed score marks. One piece construction. 9½" x 11¼" full pocket on inside folder front. Folder front NOT undercut.

Letter Size- Overall: 9½" x 12¼" Body: 9½" x 11¼"

Stock #	Sub Wt.	Color	Qty/Bx	Qty/Ctn
F84020	11 pt.	Manila	50	250
F84040	14 pt.	Manila	50	250

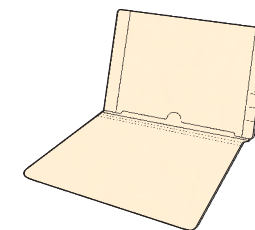

Letter—Folders with Pocket

Extended full cut reinforced end tab. 8 embossed score marks. One piece construction. 9½" x 12¼" full pocket with thumb notch on inside folder back. Folder front NOT undercut.

Letter Size- Overall: 9½" x 12¼" Body: 9½" x 11¼"

Stock #	Sub Wt.	Color	Qty/Bx	Qty/Ctn
F84014	11 pt.	Manila	50	250

Folder Colors



Pressboard Classification Folders

Classification Folders provide ways to segment information within folders. Fast, easy identification and access to contents within each section is possible; eliminating the need for more than one folder for the same subject.

Type II Pressboard

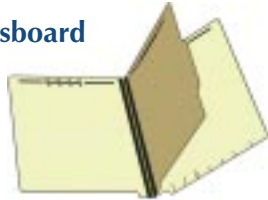

End Tab Pressboard Classification

Type II 25 pt. Full cut. 8 embossed score marks. Tyvek® gussets. Two 2" capacity embedded fasteners in positions 1 & 3. 17 pt. Kraft divider with a 1" twin prong fastener in position 1. Divider 2/5 cut right of center. Folder front undercut.

Letter Size- Overall: 9½" x 12½" Body: 9½" x 11¼"

Stock #	Sub Wt.	Color	Qty/Bx	Qty/Ctn
2" Expansion- 1 Divider				
F24112	25 pt.	Pearl	15	75
F21812	25 pt.	Red	15	75

Legal Size- Overall: 9½" x 15¼" Body: 9½" x 14¾"

Stock #	Sub Wt.	Color	Qty/Bx	Qty/Ctn
F24212	25 pt.	Pearl	15	75
F21912	25 pt.	Red	15	75

NOTE: See page 19 for fastener position chart.



End Tab Pressboard Classification

Type II 25 pt. Full cut. 8 embossed score marks. Tyvek® gussets. Two 2" capacity embedded fasteners in positions 1 & 3. Two 17 pt. Kraft dividers with a 1" twin prong fastener in position 1 in each divider. Dividers 1/3 cut center and right positions. Folder front undercut.

Letter Size- Overall: 9½" x 12¼" Body: 9½" x 11¼"

Stock #	Sub Wt.	Color	Qty/Bx	Qty/Ctn
2" Expansion- 2 Dividers				
F24122	25 pt.	Pearl	15	75
F21822	25 pt.	Red	15	75



PRESSBOARD & CLASSIFICATION FOLDERS

End Tab Pressboard Classification *continued*

Legal Size- Overall: 9½" x 15¼" Body: 9½" x 14¾"

Stock #	Sub Wt.	Color	Qty/Bx	Qty/Ctn
2" Expansion- 1 Divider				
F24222	25 pt.	Pearl	15	75
F21922	25 pt.	Red	15	75

NOTE: See page 19 for fastener position chart.

Pressboard Folders with Fasteners

Type III 25 pt. green. Full cut end tab. 8 embossed score marks. Tyvek® gussets. 2" capacity embedded fastener installed.

Letter Size- Overall: 9½" x 12¼" Body: 9½" x 11¼"

Stock #	Sub Wt.	Color	Position	Qty/Bx	Qty/Ctn
F20107	25 pt.	Green	—	25	125
F20108	25 pt.	Green	1 & 3	25	125

Legal Size- Overall: 9½" x 15¼" Body: 9½" x 14¾"

F21705	25 pt.	Green	1 & 3	25	125
--------	--------	-------	-------	----	-----

NOTE: See page 19 for fastener position chart.

Type III Pressboard

Type III Pressboard is a durable and economic folder constructed of functional 25 pt. stock.

Type III 25 pt. Full cut. 8 embossed score marks. Tyvek® gussets. Two 2" capacity embedded fasteners. Two 17 pt. Kraft dividers with a 1" twin prong fastener in position 1 in each divider. Dividers 1/3 cut center and right positions. Folder front undercut.

Letter Size- Overall: 9½" x 12¼" Body: 9½" x 11¼"

Stock #	Sub Wt.	Color	Position	Qty/Bx	Qty/Ctn
3" Expansion- 2 Dividers					
F24123	25 pt.	Green	1 & 3	15	75
F24124	25 pt.	Red	1 & 3	15	75

Legal Size- Overall: 9½" x 15¼" Body: 9½" x 14¾"

F24223	25 pt.	Green	1 & 3	15	75
F24224	25 pt.	Red	1 & 3	15	75

NOTE: See page 19 for fastener position chart.

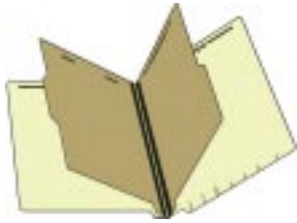

End Tab Pressboard Classification

Type III 25 pt. Full cut. 8 embossed score marks. Tyvek® gussets. Two 2" capacity embedded fasteners in positions 1 & 3. Two 17pt. Kraft dividers with a 1" twin prong fastener in position 1 in each divider. Dividers 1/3 cut center and right positions. Folder front undercut.

Letter Size- Overall: 9½" x 12¼" Body: 9½" x 11¼"

Stock #	Sub Wt.	Color	Qty/Bx	Qty/Ctn
2" Expansion- 2 Dividers				
F24113	25 pt.	Green	15	75
F24114	25 pt.	Red	15	75

Legal Size- Overall: 9½" x 15¼" Body: 9½" x 14¼"

Stock #	Sub Wt.	Color	Qty/Bx	Qty/Ctn
F24213	25 pt.	Green	15	75
F24214	25 pt.	Red	15	75

NOTE: See page 19 for fastener position chart.

Pressboard Binders - Type I Genuine

The bulkiest briefs, pleadings and working papers cannot overload your folders when you use Redweld® 2-piece binders. Available in open end or open side in letter and legal sizes. They are also ideal for presenting reports and briefs to clients.

Type I 20 pt. red or black. 2" capacity ACCO™ fastener installed either in a top or side position.

Letter Size- 9" x 11½"

Stock #	Sub Wt.	Position*	Qty/Ctn
91230EA	20 pt.	top edge 2¾"	50
91230SA	20 pt.	side edge 8½"	50

Legal Size- 9½" x 14½"

91240EA	20 pt.	top edge 2¾"	50
91240SA	20 pt.	side edge 8½"	50

*Measured from center to center

Econo-Classifile™ Folders

Designed for cost efficiency, providing the same organizing function as pressboard at a savings of 40% or more.

Folder strength and durability are assured with laminated construction and poly reinforcement.

End Tab Econo-Classifile™

Full cut reinforced end tab and top edge. 8 embossed score marks. Two 2" capacity bonded fasteners in positions 1 and 3. 28 pt. manila (2-ply laminated) dividers with a 1" twin prong fastener. Poly-reinforced expansion gussets.

Letter Size- Overall: 9½" x 12¼" Body: 9½" x 11¼"

Stock #	Sub Wt.	Color	Qty/Bx	Qty/Ctn
2" Expansion- 1 Divider				
F14141	14 pt.	Manila	25	100
F14141 B	14 pt.	Blue	25	100
F14141 R	14 pt.	Red	25	100
F14141 G	14 pt.	Green	25	100
F14141 Y	14 pt.	Yellow	25	100

3" Expansion- 2 Dividers

F14142	14 pt.	Manila	15	75
F14142 B	14 pt.	Blue	15	75
F14142 R	14 pt.	Red	15	75
F14142 G	14 pt.	Green	15	75
F14142 Y	14 pt.	Yellow	15	75

Legal Size- Overall: 9½" x 15¼" Body: 9½" x 14¼"

2" Expansion- 1 Divider

F14143	14 pt.	Manila	25	100
--------	--------	--------	----	-----

NOTE: See page 12 for folder colors and page 19 for fastener position chart.

Top Tab Econo-Classifile™

Straight cut reinforced top tab. 4 embossed score marks. Two 2" capacity bonded fasteners in positions 1 and 3. 28 pt. manila (2-ply laminated) dividers with a 1" twin prong fastener. Poly-reinforced expansion gussets.

Letter Size- Overall: 9½" x 11¼" Body: 9" x 11¼"

Stock #	Sub Wt.	Color	Qty/Bx	Qty/Ctn
2" Expansion- 1 Divider				
F14151	14 pt.	Manila	25	100

3" Expansion- 2 Dividers

F14152	14 pt.	Manila	15	75
--------	--------	--------	----	----

Pressboard Colors—Type I Genuine

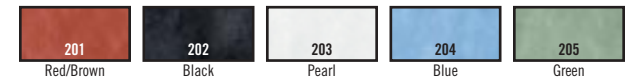

Pressboard Colors—Type II



Redweld® Pressboard 2000

Select Redweld® Pressboard 2000 as a sturdy 25 pt. stock available in 9 colors. Design a pressboard folder, classification folder or binder cover; in letter or legal sizes.

Redweld® Pressboard Type 2000 Colors

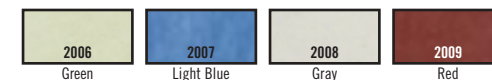



EXHIBIT DIVIDERS

Indexes are designed for maximum organization of any filing system. Provide quick and easy referencing for access to pertinent information in an efficient manner.

Indexes can be custom-designed to individual specifications which can include artwork, logos and clear on color poly laminated tabs.

Avery® style stock Exhibit tabs are 80lb. acid-free stock with clear Mylar® reinforced tabs and are recycled with 30% post consumer waste.

Numeric—Letter—Side Tab

Collated side tabs are packaged 25 consecutive numbers per set. Side tab is 1/25 cut.

Stock #	Size	Package*	Qty/Box
ST11001	11"	1–25	10 sets
ST11026	11"	26–50	10 sets
ST11051	11"	51–75	10 sets
ST11076	11"	76–100	10 sets
ST11101	11"	101–125	10 sets
ST11126	11"	126–150	10 sets
ST11151	11"	151–175	10 sets
ST11176	11"	176–200	10 sets
ST11201	11"	201–225	10 sets
ST11226	11"	226–250	10 sets
ST11251	11"	251–275	10 sets
ST11276	11"	276–300	10 sets

*301–8000 available

Individual Numeric—Letter—Side Tab

25 dividers of the same number are packaged together. To Order: Specify the individual number required:
(Ex.) Order ST12XXX; ST12201 (Bank of 201)

Numeric—Letter—Bottom Tab

Collated bottom tabs are packaged 25 consecutive numbers per set. Bottom tab is 1/10 cut.

Stock #	Size	Package	Qty/Box
BT11001	11"	1–25	10 sets

Individual Numeric—Letter—Bottom Tab

25 dividers of the same number are packaged together. To Order: Specify the individual number required:
(Ex.) Order BT12XXX; BT12014 (Bank of 14)

Numeric—Legal—Side Tab

Collated side tabs are packaged 25 consecutive numbers per set.
Side tab is 1/25 cut.

Stock #	Size	Package*	Qty/Box
ST14001	14"	1–25	10 sets
ST14026	14"	26–50	10 sets
ST14051	14"	51–75	10 sets
ST14076	14"	76–100	10 sets

*101–500 available

Individual Numeric—Legal—Side Tab

25 dividers of the same number are packaged together. To Order: Specify the individual number required:
(Ex.) Order ST15XXX; ST150099 (Bank of 99)

Numeric—Letter—Exhibit—Side Tab

Collated side tabs are packaged 25 consecutive numbers per set.
Side tab is 1/10 cut.

Stock #	Size	Description*	Qty/Box
SX11001	11"	Exhibit 1–25	10 sets
SX11026	11"	Exhibit 26–50	10 sets

*51–100 available

Individual Numeric—Letter—Exhibit—Side Tab

25 dividers of the same number are packaged together. To Order: Specify the individual number required:
(Ex.) Order SX12XXX; SX12049 (Bank of 49)

Numeric—Letter—Exhibit—Bottom Tab

Collated bottom tabs are packaged 25 consecutive numbers per set.
Bottom tab is 1/5 cut.

Stock #	Size	Description	Qty/Box
BX11001	11"	Exhibit 1–25	10 sets
BX11026	11"	Exhibit 26–50	10 sets

Individual Numeric—Exhibit—Bottom Tab

25 dividers of the same number are packaged together. To Order: Specify the individual number required:
(Ex.) Order BX12XXX; BX12036 (Bank of 36)

Alphabetic—Side Tab

Collated side tabs are packaged 26 consecutive A–Z per set.
Side tab is 1/26 cut.

Stock #	Size	Description	Qty/Box
AS11AZ	11"	A–Z	10 sets
AS14AZ	14"	A–Z	10 sets

Individual Alphabetic—Side Tab

25 dividers of the same letter are packaged together. To Order: Specify the individual letter required:
(Ex.) 11" Letter size: AS12X; AS12C (Bank of C),
14" Legal size: AS15X; AS15M (Bank of M)

Alphabetic—Letter—Bottom Tab

Collated bottom tabs are packaged 26 consecutive A–Z per set.
Bottom tab is 1/10 cut.

Stock #	Size	Description	Qty/Box
AB11AZ	11"	A–Z	10 sets

Individual Alphabetic—Letter—Bottom Tab

25 dividers of the same letter are packaged together. To Order: Specify the individual letter required:
(Ex.) AB12X; AB12E (Bank of E)

Alphabetic—Letter—Exhibit—Side Tab

Collated side tabs are packaged 26 consecutive Exhibit A–Z per set.
Side tab is 1/10 cut.

Stock #	Size	Description	Qty/Box
AS11EAZ	11"	Exhibit A–Z	10 sets

Individual Alphabetic—Exhibit—Side Tab

25 dividers of the same letter are packaged together. To Order: Specify the individual exhibit alphabetic tab required:
(Ex.) AS12X; AS12D (Bank of D)

Alphabetic—Letter—Exhibit—Bottom Tab

Collated bottom tabs are packaged 26 consecutive Exhibit A–Z per set.
Bottom tab is 1/5 cut.

Stock #	Size	Description	Qty/Box
AB11EAZ	11"	Exhibit A–Z	10 sets

Individual Alphabetic—Exhibit—Bottom Tab

25 dividers of the same letter are packaged together. To Order: Specify the individual exhibit alphabetic tab required:
(Ex.) AB12X; AB12T (Bank of T)

Month—Letter—Side Tab

Collated side tabs contain 1 complete set January–December, 2 sets per package. Side tabs are 1/12 cut.

Stock #	Size	Description	Qty/Box
MS11	11"	January–December	10 sets

Table of Contents—Side Tab

1 side tab set contains 25 dividers with Table of Contents printed.

Stock #	Size	Description	Qty/Box
TS11	11"	Table of Contents	10 sets
TS14	14"	Table of Contents	10 sets

Index—Side Tab

1 side tab set contains 25 dividers with Index printed.

Stock #	Size	Description	Qty/Box
IS11	11"	Index	10 sets
IS14	14"	Index	10 sets

CUSTOM-TAILORED

**EXHIBIT
DIVIDERS**

see pgs 22-24

Design Custom Indexes in 4 Easy Steps!

1. Select Material and Size

Standard stock for indexes includes 100# white or buff, and many other paper stocks to choose from as well. Special paper requests are also accommodated.

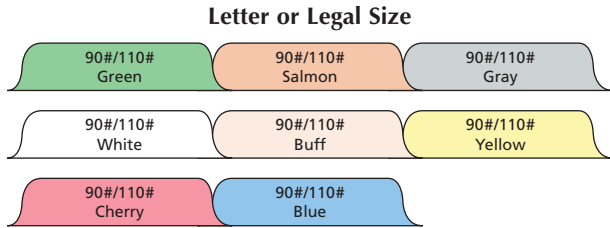

2. Specify Tab Size and Position

Tab size indicates the tab's extension from the index edge.

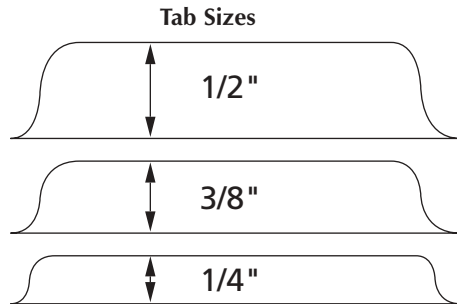

The tabs shown above are actual size. Note that position #1 starts at the left. Plan ahead! Consider leaving an empty position for future use.

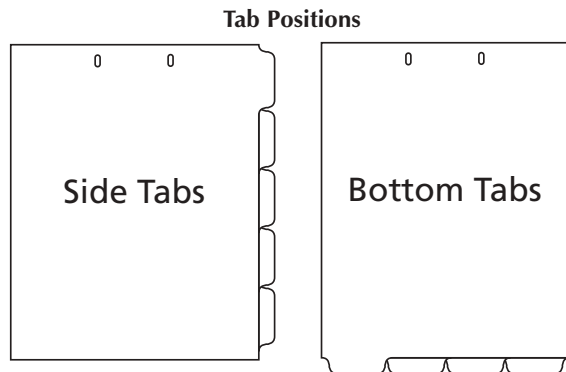

3. Specify Tab Color and Print Styles

Tab Styles

Select plain, printed or Mylar® tabs.

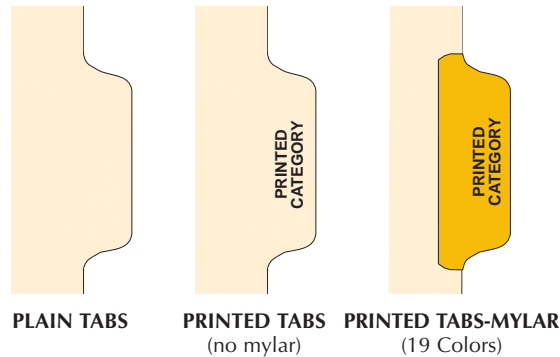

Print Styles

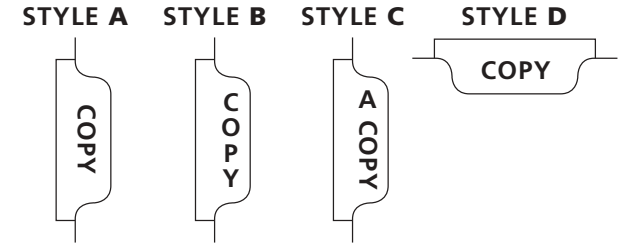

Mylar® Tab Colors

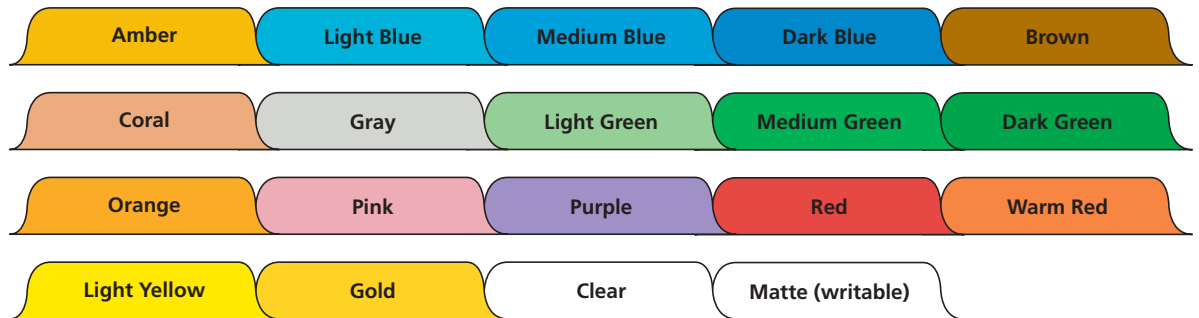

4. Specify Bindery and Packaging Options

Collated: Tab sets are packaged together as a complete set.

Non-Collated: Each tab title is packaged individually.

CUSTOM-TAILORED
**EXHIBIT
DIVIDERS**

Tyvek® Mailing Envelopes

DuPont Tyvek® Envelopes are high performance mailers. Tyvek® resists punctures, tears and moisture better than any other envelope. Yet as durable as they are, they are remarkably light to keep postage costs down.

14 lb. Tyvek®—Open End*

Stock #	Size	Border	Qty/Box	Qty/Ctn
H1320	6" x 9"	Plain	100	1000
H1330	6" x 9"	First Class	100	1000
H1350	6½" x 9½"	Plain	100	1000
H1460	9" x 12"	Plain	100	500
H1470	9" x 12"	First Class	100	500
H1520	9½" x 12½"	Plain	100	500
H1530	9½" x 12½"	First Class	100	500
H1580	10" x 13"	Plain	100	500
H1590	10" x 13"	First Class	100	500
H1660	10" x 15"	Plain	100	500
H1670	10" x 15"	First Class	100	500
H1790	12" x 15½"	Plain	100	500
H1800	12" x 15½"	First Class	100	500

*Flap-stik® closure

14 lb. Tyvek®—Open Side*

Stock #	Size	Border	Qty/Box	Qty/Ctn
H2980	9" x 12"	Plain	100	500
H2910	10" x 13"	Plain	100	500

*Flap-stik® closure

18 lb. Tyvek®—Open End*

Stock #	Size	Border	Qty/Ctn
R4130	9" x 12" x 2"	Plain	100
R4200	10" x 13" x 1½"	Plain	100
R4210	10" x 13" x 1½"	First Class	100
R4290	12" x 16" x 2"	Plain	100
R4300	12" x 16" x 2"	First Class	100

*Flap-stik® closure

18 lb. Tyvek®—Open Side*

Stock #	Size	Border	Qty/Ctn
R4360	10" x 12" x 1½"	Plain	100
R4430	10" x 13" x 2"	Plain	100
R4440	10" x 13" x 2"	First Class	100
R4492	12" x 16" x 2"	Plain	100
R4495	12" x 16" x 2"	First Class	100

*Flap-stik® closure



MAILING ENVELOPES

Redweld® Professional Mailers

28 lb. Brown Kraft—Open Side*

Stock #	Size	Border	Qty/Ctn
28010	4½" x 10½"	Plain	500
28110	4¾" x 11"	Plain	500
28210	9" x 12"	Plain	500
28310	10" x 13"	Plain	500

*Regular Gum closure

28 lb. Grey Kraft—Open Side*

Stock #	Size	Border	Qty/Ctn
28000	4½" x 10½"	Plain	500
28100	4¾" x 11"	Plain	500
28200	9" x 12"	Plain	500
28300	10" x 13"	Plain	500

*Regular Gum closure

40 lb. Brown Kraft—Open Side*

Stock #	Size	Border	Qty/Ctn
E8905	5" x 11"	Plain	250
E8920	9½" x 11¾"	Plain	250
E8925	9½" x 12½"	Plain	250
E8930	10" x 15"	Plain	250

*Flap-stik® closure

18 pt. White Board—Open Side*

Glossy coated board provides an excellent surface for printing. Lightweight for mailing, yet still offers protection.

Stock #	Size	Border	Qty/Ctn
E7130	10" x 13"	Plain	100

*Flap-stik® closure

Tyvek® is a registered trademark of Dupont for its brand of protective material.

Redweld® Expanding Retention Pockets can easily be attached to the inside of a fastener folder or binder. Creates a filing solution for those documents that should not be hole punched. Ideal for disks, annual reports, evidence and project reports.

Retention Pockets with 1" Expansion

Stock #	Size	Sub Wt.	Holes	Qty/Ctn
04693	9" x 11½"	50 lb. Brown Kraft	Side	250
04698	9" x 13¾"	40 lb. Brown Kraft	Top	100
04696	9" x 13¾"	11 pt. Manila	Top	100
04697	9" x 13¾"	8 pt. Grey	Top	100
04690	9" x 14"	50 lb. Brown Kraft	Top	250
04692	9¼" x 10¾"	14 pt. Acid-free Manila	Side	250

Filing Accessories—Fasteners

Insure your papers remain in your pressboard folders and binders by adding fasteners.

Fastener Position Chart

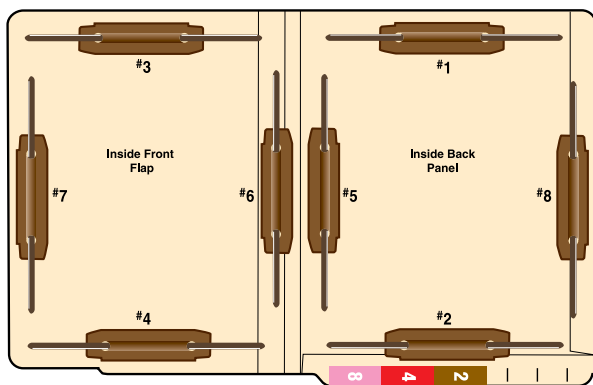

Illustrated are standard fastener positions for all folders



REDWELD® RETENTION POCKETS

Types of Fasteners

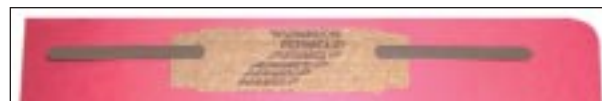

PERMCLIP™—A 2" prong fastener permanently adhered to pressboard.



H-FASTENER—A 2" prong fastener permanently embedded into pressboard.



ACCO™—A 2 piece fastener used to join a two piece binder. Available in a variety of sizes depending if the binder is an open end (flips up from bottom like a memo pad) or is an open side (opens from left or right side like a book).



SLIDEWAY—Fastener bases for standard Acco™ fasteners. Your papers can be removed at the end of the period by simply slipping them out, intact, indexed and fastened together for transfer to long term storage in file pockets or envelopes.

Filing Accessories—Labels



BARKLEY 1" H A-Z Set (Rolls)—polylaminated, two-tier organizer

Stock #	Size	Labels/Roll	Rolls/Set
F01187	1" x 1½"	500	27



BARKLEY 1" H, Color Code Plus™ A-Z Set (Rolls)—polylaminated, two-tier organizer

Stock #	Size	Labels/Roll	Rolls/Set
F02137	1" x 1½"	500	26



BARKLEY 1/2"H A-Z Set (Rolls)—polylaminated, two-tier organizer

Stock #	Size	Labels/Roll	Rolls/Set
F01127	½" x 1½"	500	27

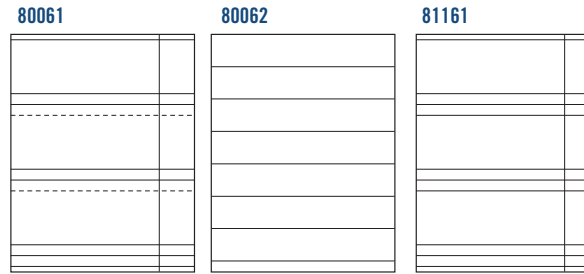

LEGAL KEY LABELS

Stock #	Sheet Size	Stock	Sheets/Bx
80061	8 ½" x 11"	White	1,000
80062	8 ½" x 11"	White	1,000
81161	8 ½" x 11"	White	1,000



JAN-DEC Set (Rolls)—polylaminated

Stock #	Label Size	Labels/Roll	Rolls/Set
F01062	¾" x 1½"	250	12



JAN-DEC Set (Rolls)—Kimdura® Organizer.

Stock #	Label Size	Labels/Roll	Rolls/Set
F01396	½" x 1"	500	12



AMES Year (Rolls)

Stock #	Label Size	Stock	Labels/Roll
F86105*	1½" x 1½"	Paper	500

*To specify the year, please add the last two digits of the year to the stock number



BARKLEY Year (Rolls)—¾" H, polylaminated

Stock #	Label Size	Stock	Labels/Roll
F92020*	¾" x 1½"	Polylamine	500

*To specify the year, please add the last two digits of the year to the stock number



BARKLEY Year (Rolls)—Color Code Plus™, polylaminated

Stock #	Label Size	Stock	Labels/Roll
F94220*	¾" x 1½"	Polylamine	500

*To specify the year, please add the last two digits of the year to the stock number



SAV-TYME Year (Rolls)—polylaminated

Stock #	Label Size	Stock	Labels/Roll
F91720*	¾" x 1½"	Polylamine	500

*To specify the year, please add the last two digits of the year to the stock number



SMEAD Year (Rolls)—paper

Stock #	Label Size	Stock	Labels/Roll
F86205*	½" x 1¼"	Paper	500

*To specify the year, please add the last two digits of the year to the stock number

Filing Accessories—Outguides

Outguides represent a positive means of controlling files removed from the file area. The “out” tab system provides a visual alert to hasten the return of files. When all or part of a file is removed, the guide is placed in the file. The large pocket can hold the remaining files or it can accumulate other data while the folder is out.

Vinyl Outguides—Center Tab

Stock #	Size	Color	Qty/Ctn
0G7010	9½" x 12⅞"	Red	50
0G7020	9½" x 12⅞"	Green	50
0G7030	9½" x 12⅞"	Yellow	50
0G7040	9½" x 12⅞"	Blue	50
0G7050	9½" x 12⅞"	Pink	50
0G7060	9½" x 12⅞"	Orange	50
0G7070	9½" x 12⅞"	Purple	50
0G7045	9½" x 12⅞"	Lt. Blue	50
0G7075	9½" x 12⅞"	Lavender	50
0G7000	9½" x 12⅞"	Clear	50
F69008	9½" x 15¼"	Red	50

Vinyl Outguides—Bottom Tab, Full Pocket

Stock #	Size	Color	Qty/Ctn
0G6200	9½" x 13"	Clear	50
0G6210	9½" x 13"	Red	25
0G6220	9½" x 13"	Green	25
0G6230	9½" x 13"	Yellow	25
0G6240	9½" x 13"	Blue	25
0G6245	9½" x 13"	Pink	25
0G6250	9½" x 13"	Orange	25
0G6260	9½" x 13"	Purple	25
0G6270	9½" x 13"	Lt. Blue	25
0G6275	9½" x 13"	Lavender	25
F69005	9½" x 15¼"	Red	50

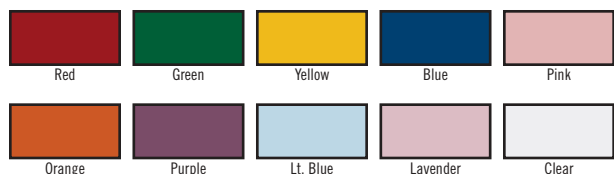

OUTGUIDES

Pressboard Outguides

25 pt. Type II pearl pressboard. Tabs in top position. 25 division alphabetic black print on white inserts pre-inserted or blank white inserts. Metal tabs include insert and clear mylar window facing.

Plastic Tab: 2½" x ¾" Dual View®
Metal Tab: 1¾" x ¾" Dual Window

Super Letter- Body: 9½" x 12¼" - Plus Tab

Stock #	Tab Color	Tab	Qty/Set	Qty/Bx
Guide Sets- Alphabetic (A-Z)				
F68655	Clear	Plastic	25	—
F68657	—	Metal	25	—

Guide Sets- Blank Inserts

F68666	Clear	Plastic	—	25
F68667	—	Metal	—	25

Pressboard Outguides *continued*

Super Legal- Body: 9½" x 15¼" - Plus Tab

Guide Sets- Alphabetic (A-Z)

F69655	Clear	Plastic	25	—
--------	-------	---------	----	---

Guide Sets- Blank Inserts

F69635	Clear	Plastic	—	25
--------	-------	---------	---	----

CUSTOM-TAILORED
OUTGUIDES
see pgs 22-24

Made-To-Order—construction

Custom expanding envelopes and pockets are constructed from five pieces; the gusset, front and back inside liners and the front and back are primary stock. This 5-piece construction guarantees a sturdy product with maximum durability, flexibility and resistance to soiling and marring. Custom expandables are available in letter, legal size or design a size to fit your filing requirements.

Two acid-free inside liners mounted onto the gusset form the inside case.

Heavy duty material is glue-welded onto the liners to form the pocket or envelope.

Finally, the necessary hardware is added to the product: metal tabs, pull tapes, etc.

Made-To-Order—rivets

Rivets provide additional reinforcement and durability at the stress point where the gusset meets the folder. Rivets are standard on side tab pockets and envelopes. They may be added to any product at a minimal cost.

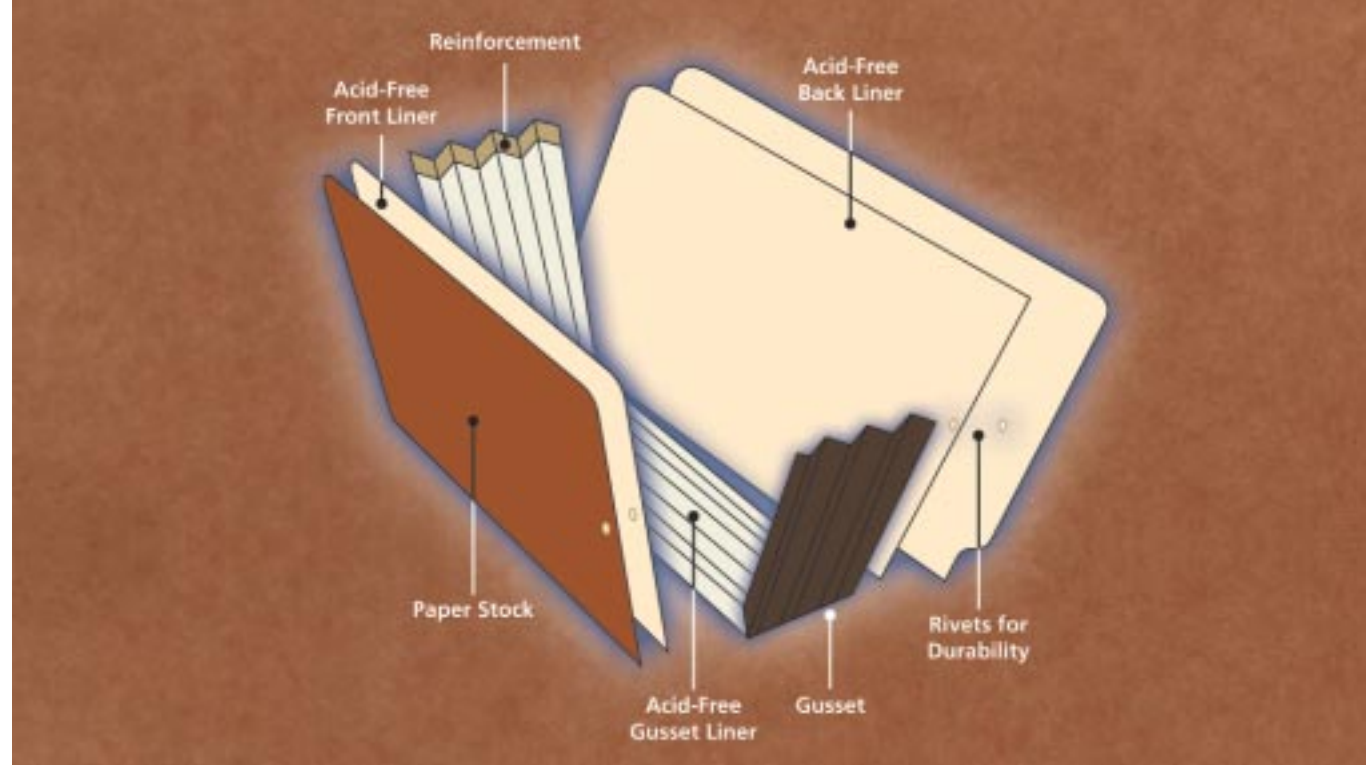

MADE-TO-ORDER

Made-To-Order—closures

Select the fastener style based on individual filing needs. Elastic cord, tie tape, button and string or velcro closures are available on any custom design folder.



Made-To-Order—tab styles

Custom filing products may be manufactured with a variety of custom tab styles. Common tab styles include full side tab, shelf tab, top side tab, metal tab, and back tab. Location can be right side, left side or front. The dimensions (left and right) can also be changed.

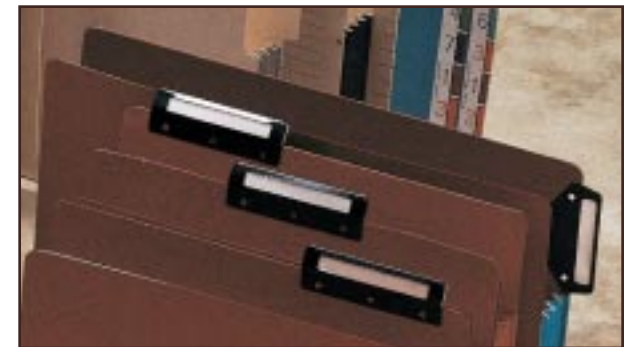



Made-To-Order—color gussets

Tyvek® gussets are tear-resistant and have a superior shelf life.

The gusset is the most visible part of the expandable, as well as the most susceptible to stress. Two types of gussets: Tyvek® reinforced non-tear gussets and Duragusset™ mylar-reinforced gussets are offered.

Gussets are composed of a heavy duty, acid-free paper which is laminated with Tyvek® and reinforced with mylar for extra strength and durability. The gusset can be laminated with a choice of 26 colors for color coding applications.

Duragusset™ gussets provide an inexpensive alternative to reinforcing the pocket. Excellent choice for low volume or low usage.

Made-To-Order—printing

Custom expanding filing products can be imprinted to individual specifications.

Important information is readily available by adding a printed form to the expandables.



Tyvek® Colors

105 Frosty White	100 Black	130 Scarlet Red	119 Lemon Yellow
132 Dusty Rose	124 Lime	114 Russet	143 Cerulean Blue
133 Orange	131 Blue/Violet	117 Taupe	152 Pearl Green
194 Manila	123 Avocado	115 Desert Sand	192 Goldenrod
126 Moss Green	142 Pale Blue	157 Dove Gray	150 Banker's Gray
134 Magenta	120 Spring Green	111 Chocolate Brown	106 New Brown
145 Dark Blue	135 Maroon		

CUSTOM-TAILORED
**FILING
SYSTEMS**

Made-To-Order—dividers and subfolders

Dividers and subfolders are available to fit perfectly into expanding file pockets and envelopes. Services include: printed tab title, mylar coating, tabbing, collating and insertion.



Made-To-Order—fasteners

Fasteners hold documents within a folder securely. Choose from a variety of fasteners (Permclip, H-fastener, Acco™, Slideway, Tang and Twin Prong). Fasteners have a capacity of one or two inches and can be installed in a variety of positions.



Made-To-Order—pockets

Poly, manila, kraft or bristol pockets can be installed into any folder. Provide a simple and quick way to organize documents while eliminating the need for punching.

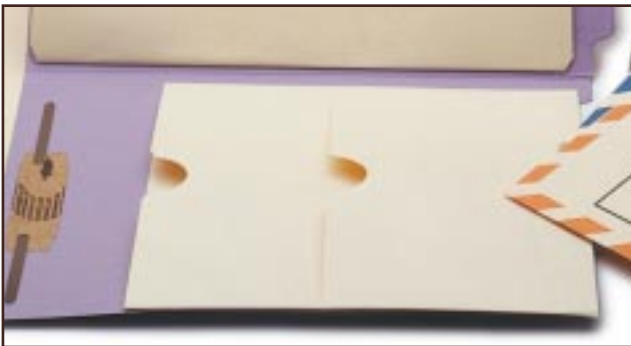

CUSTOM-TAILORED
FILING
SYSTEMS